

細部放大圖 A  
比例 1 : 5

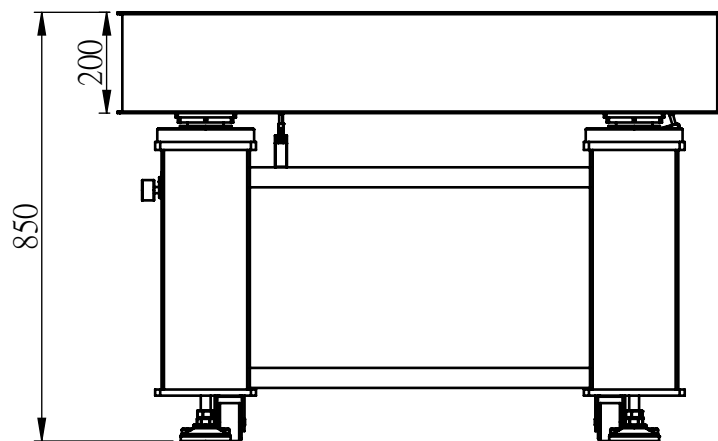

M-OTA3-90120-20