

細部放大圖 A
比例 1:5

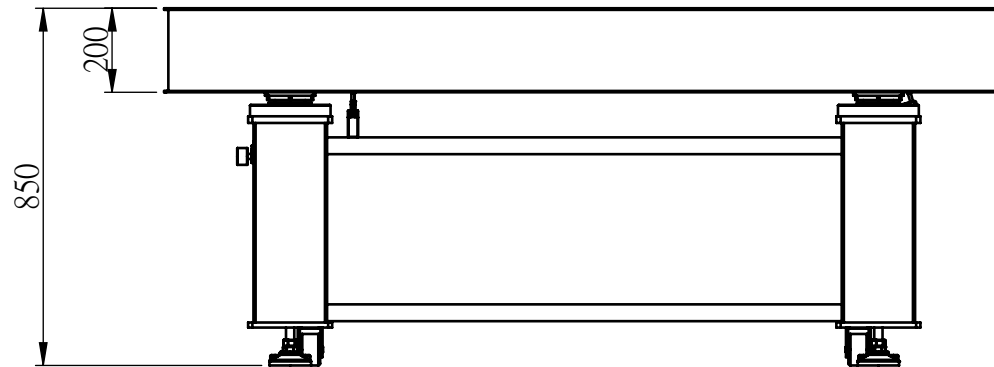

M-OTA3-100200-20