

細部放大圖 A
比例 1 : 5

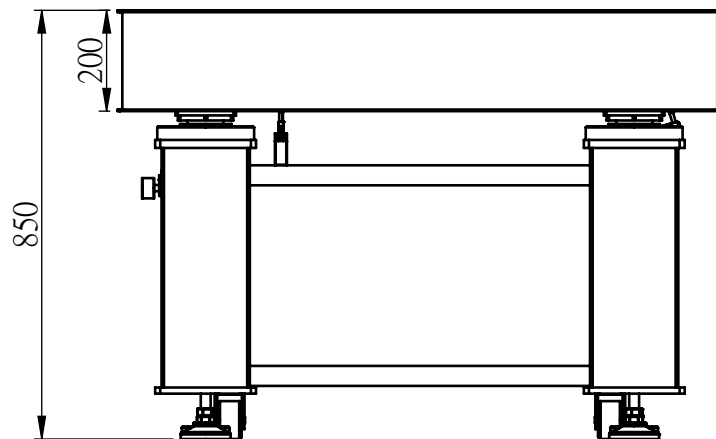

M-OTA4-90120-20