

細部放大圖 A  
比例 2 : 15

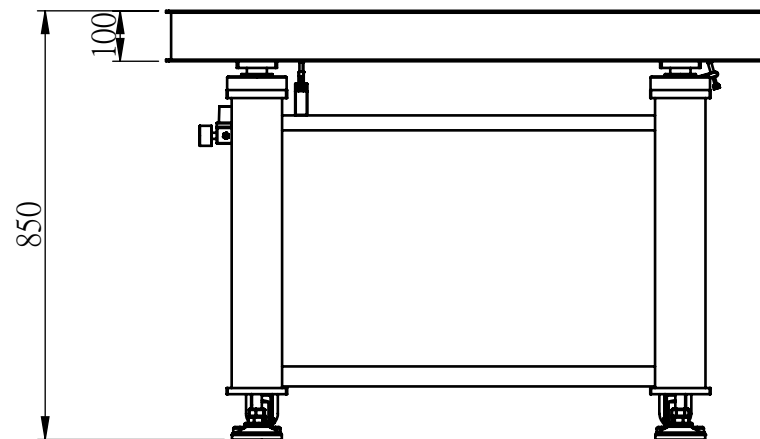

M-OTB4-90120-10