

細部放大圖 A  
比例 1:5

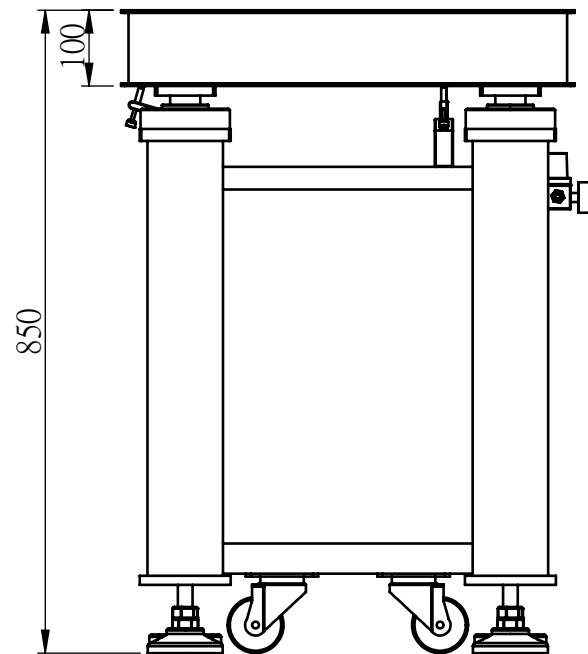

M-OTB4-4560-10