

細部放大圖 A  
比例 1:6

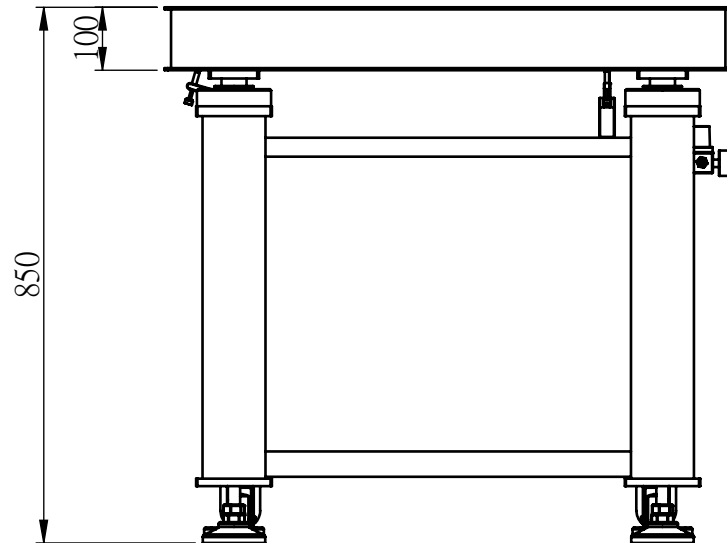

M-OTB3-7590-10