

細部放大圖 A
比例 1:5

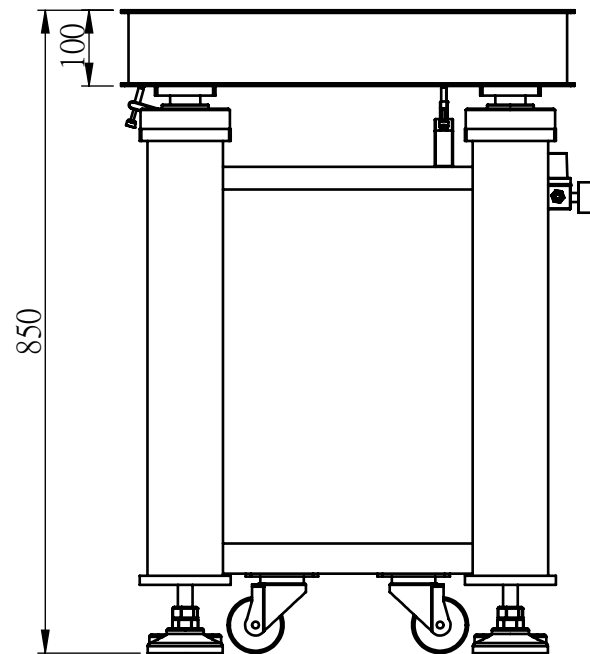

M-OTB3-4560-10